

Dimensions

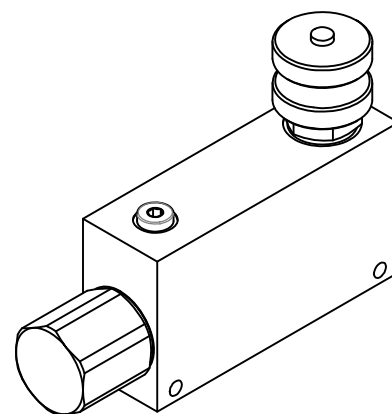

Hydraulic Symbol

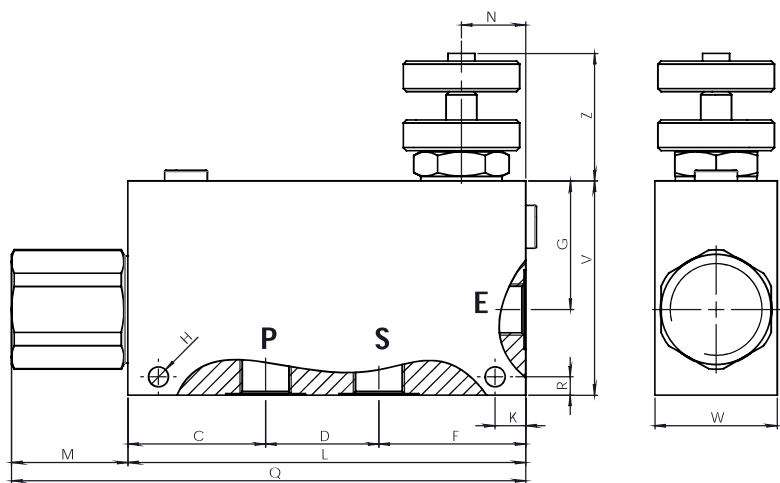
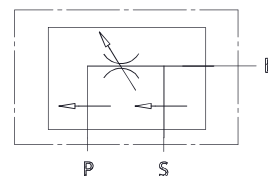

Size	E-P-S BSP	C	D	F	G	H	K	L	M	N	R	Q	V	W	Z	Weight kg
02	3/8	48	37	45	42	8,5	10	130	38	21	6	172	70	40	42max	1,37
03	1/2	48	37	45	42	8,5	10	130	38	21	6	172	70	40	42max	1,37
04	3/4	57	44	54	55	8,5	10	155	35	25	7	190	90	50	45max	2,44
05	1	55	50	50	58	8,5	10	155	35	25	7	190	100	50	45max	2,54

Features

Size	02	03	04	05
Max Pressure (bar)	260	260	260	260
Max Inlet Flow (lpm)	50	85	150	190
Max Adjustment Flow (lpm)	40	60	90	120

Curves

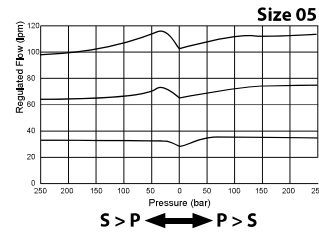
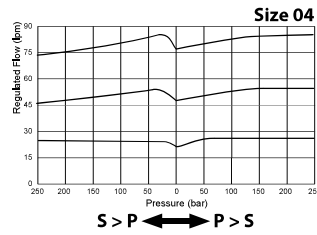
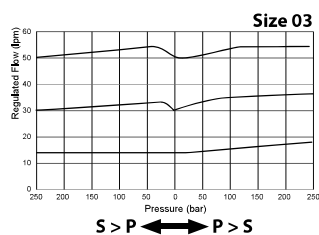
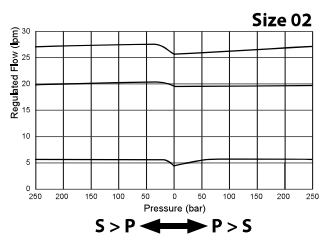

Materials: Aluminium body, hardened steel inner parts.

Ordering Code

PVEL --

	Size BSP
02	3/8
03	1/2
04	3/4
05	1

Ordering Code Example: PVEL03 = 1/2 BSP.