

DNP Series Low Pressure Diaphragm Pressure Switch

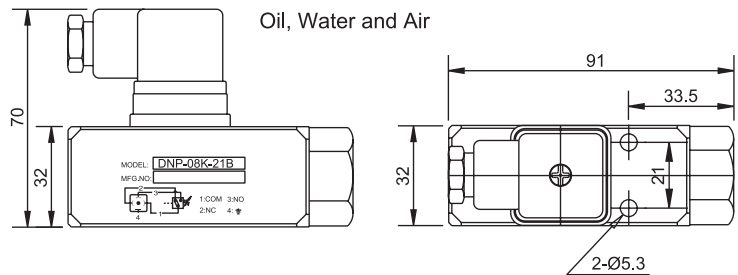

■ DIMENSIONS:

UNIT: mm



Features:

1. Low pressure type diaphragm pressure switch.
2. Special designed for oil, water and air in low pressure application.
3. General type, pressure adjusting by hex key wrench.
4. Service life time upto ? times.
5. Pipe connection port, 3 types of threading for choosen.
6. Weight: 0.2 kg.

■ HOW TO ORDER

DNP - 08K - 21B

Design no.:
 21B: 1/4" PT
 21B80: 1/4" PF(G)
 21B90: 1/4" NPT

Pressure adjusting range:

Model No.	Adj Range Bar	Surge pressure
02K	0.3~2	80
08K	0.6~8	80
20K	1.5~20	80

Series no.
 NP: Low Pressure Diaphragm Switch

■ WIRING DIAGRAM:

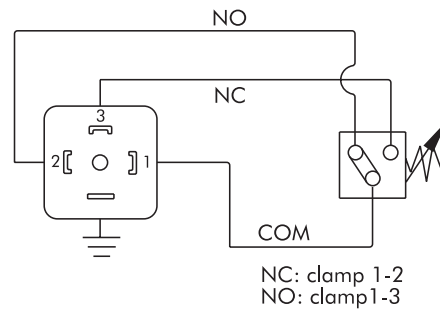

Breaking capacity	AC	DC
Voltage up to	125,250,480	125 250
Resistance load	15	0.5 0.25

■ PERFORMANCE CURVES:

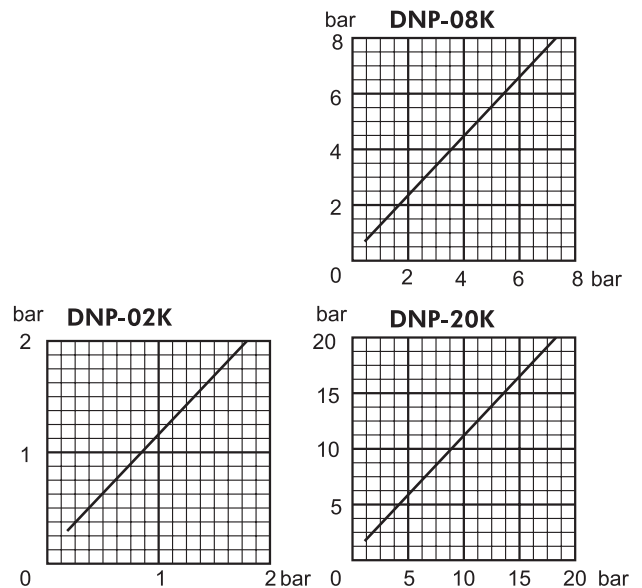

■ SCHEMATIC CROSS-SECTION

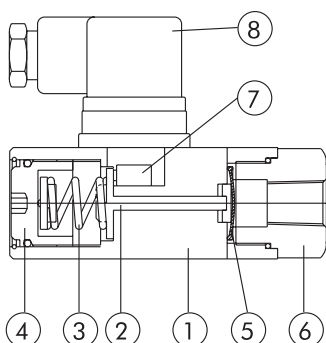

1	Body(Aluminum Alloy)	5	Diaphragm
2	Servo-Piston	6	Connection Port
3	Spring	7	Micro-Switch
4	Pressure Adj. knob	8	Wiring connector



DNB Series Pressure Switches



DIMENSIONS:

UNIT: mm

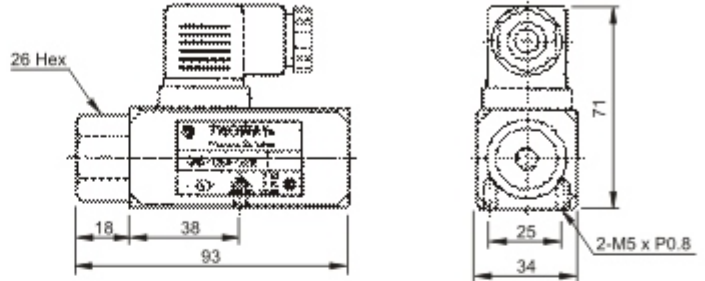

WIRING DIAGRAM:

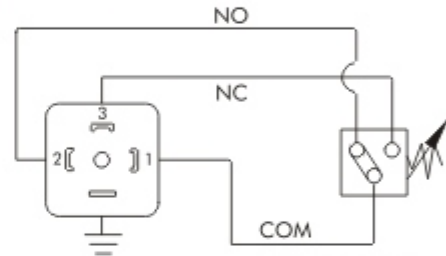

NC: clamp 1-2
NO: clamp 1-3

Breaking capacity	AC	DC
Voltage up to	125, 250	125, 250
Resistance load	5	0.5, 0.25

Features:

1. General type, pressure adjusting by hex key wrench.
2. Service life time upto 100,000 times.
3. Pipe connection port, 3 types of threading for choosen.
4. Weight: 0.6 kg.

HOW TO ORDER

DNB - 100K - 22B

Design no.:
22B: 1/4" PT
22B80: 1/4" PF(G)
22B90: 1/4" NPT

Pressure adjusting range:

Model No.	Adj Range Bar	Surge pressure
40K	5~40	150
70K	6~70	200
150K	30~150	300
250K	40~250	400

Series no.
DNB: General Type
Pressure Switch.

PERFORMANCE CURVES:

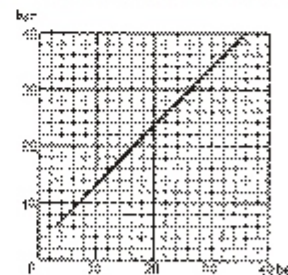

DNB-040K

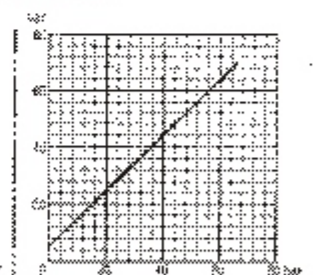

DNB-070K

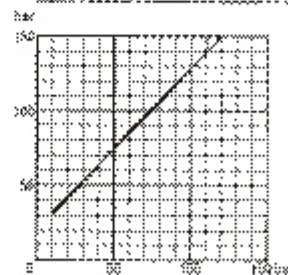

DNB-150K

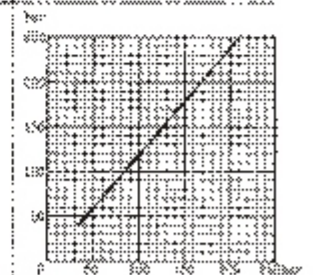

DNB-250K

SCHEMATIC CROSS-SECTION

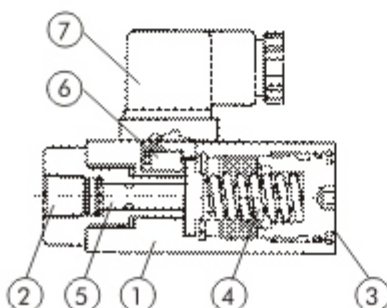

1	Body(Casting Iron)	5	Servo Piston
2	Connecting port	6	Micro Switch
3	Pressure Adj. Konb.	7	Wiring connector
4	Spring		