

FHP SERIES

IN-LINE FILTER



MPFILTRI
filtri per oleodinamica



Maximum working pressure 420 bar

Flow rates to 450 l/min

Description

FHP

FHP series filters are designed for high pressure line applications and are suitable for in-line installation. Continued research and development on both the filter bodies and the filter elements has resulted in a product line with excellent pressure drop characteristics combined with a high filtration efficiency. The transverse by-pass valve is a standard feature with this range of product. (Non bypass for servo applications is also available).

A complete line of pressure differential visual and electrical indicators are available with this series of filters.

FMP series filters are available with Reverse Flow Valve.

FHP series filters within this range are suitable for flow rates to 450 l/min. See page 13.

FHP series are specifically designed for mobile, industrial and power pack applications.

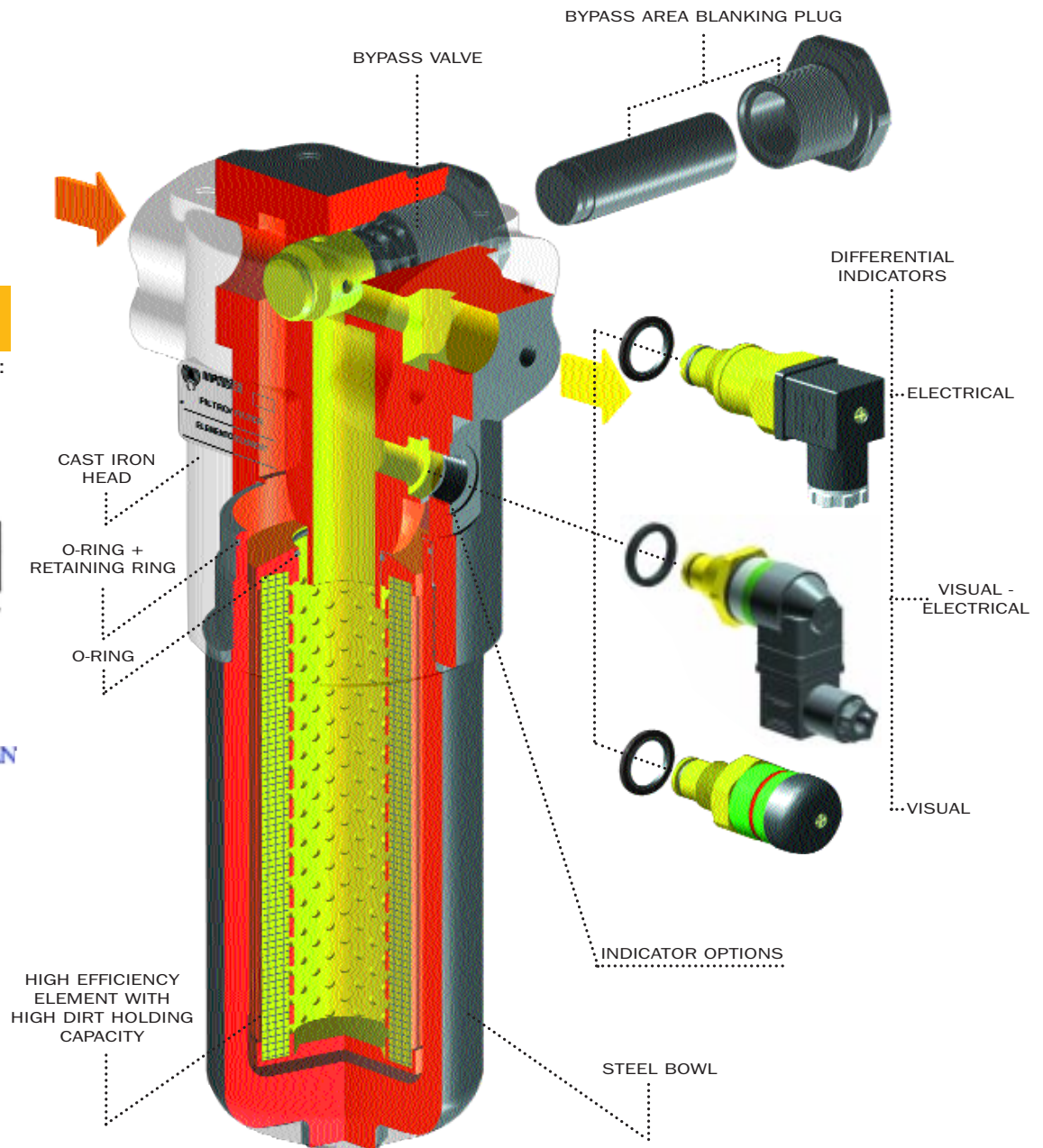

New

absolute filter elements
independently tested
in the following Institutes:

Institute of Filtration
(France)



Royal Institute of Technology



Filter element:

Filter element material

End caps:

Steel (Thermal treatment)

Support tube:

Steel (Thermal treatment)

Support frames:

Coated wire cloth

A Series

Inorganic microfibre

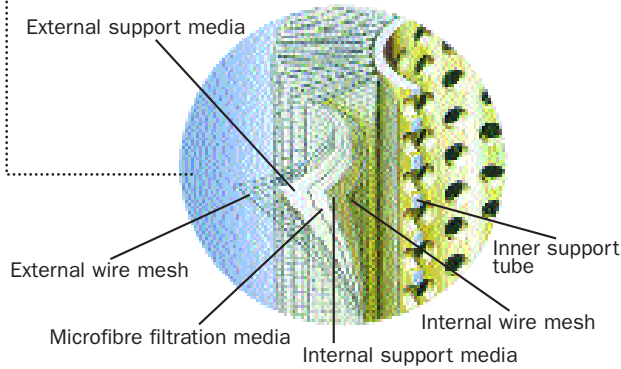

MP Filter elements - Conform to the following ISO standards

- ISO 2941 - Verification of collapse/burst resistance.
- ISO 2942 - Verification of fabrication integrity and determination of the first bubble point.
- ISO 2943 - Verification of material compatibility with fluids.
- ISO 3723 - Method for end load test.
- ISO 3724 - Verification of flow fatigue characteristics.
- ISO 3968 - Evaluation of pressure drop versus flow characteristics.
- ISO 4572 - Multi-pass method for evaluating filtration performance.

Element material Absolute filtration

A Series

New material:

Inorganic microfibre with acrylic support

New improved $\beta \geq 200$ filter elements with greater efficiency and increased dirt holding capacity

Contamination retention

as per ISO 4572: Multi-pass test.

Filter elements	Dimensions for $\beta(\mu\text{m})$ values				Filtration ratios			ΔP (bar)
	$\beta \geq 2$ (50%)	$\beta \geq 20$ (95%)	$\beta \geq 75$ (98,7%)	$\beta \geq 200$ (99,5%)	β_2	β_{10}	β_{20}	
A03	-	2	2,4	3	20	>10.000	>10.000	7
A06	-	3	4,6	6	8	> 2.000	>10.000	7
A10	3	6	7,8	10	1,5	≥ 200	>10.000	7
A25	13	19	22	25	-	> 1,5	> 35	7

N.B. Other materials giving different degrees of filtration are available on request.

Filtering area Filter elements N - ΔP 20 bar

Type HP	065-1	065-2	065-3	135-1	135-2	320-1	320-2	320-3	320-4
A03/A06	386	546	1098	895	1879	1512	3326	5428	7544
A10/A25	386	546	1098	895	1879	1512	3326	5428	7544

Values in cm²

Filtering area Filter elements H - ΔP 210 bar

Type HP	065-1	065-2	065-3	135-1	135-2	320-1	320-2	320-3	320-4
A03/A06	386	544	1094	777	1655	1475	3258	5341	7425
A10/A25	386	544	1094	777	1655	1475	3258	5341	7425

Values in cm²

Element material Nominal filtration

M Series

Square wire mesh (filtration degree is defined in microns by the maximum diameter of a sphere corresponding to the mesh size)

T Series

Triangular stainless steel wire mesh

Filtering area Filter elements N - ΔP 20 bar

Type HP	065-1	065-2	065-3	135-1	135-2	320-1	320-2	320-3	320-4
M10	374	530	1064	950	2020	1650	3645	5970	8280
M25	374	530	1064	950	2020	1650	3645	5970	8280
M60	374	530	1064	950	2020	1650	3645	5970	8280

Values in cm²

Filtering area Filter elements T - ΔP 80 bar

Type HP	065-1	065-2	065-3	135-1	135-2	320-1	320-2	320-3	320-4
T10/T25	385	545	1090	710	1500	1670	3690	6040	8380

Values in cm²

Filter body:

Materials	<p>Head Cast iron (Thermal treatment)</p> <p>Bowl Steel (Thermal treatment)</p> <p>Seals A Series: Nitrile (Buna-N) V Series: Viton</p>	<p>Bypass valve Brass</p> <p>Reverse flow (Only for 135/320-321-325 series) Steel</p> <p>Indicator Brass (with vitou seal)</p>
Working temperature	From -25 to +110°C For temperatures outside this range, please consult our Sales Network Organization	
Pressure filter body	Maximum working pressure up to 420 bar Test pressure: 630 bar Minimum burst pressure: 1250 bar	Fatigue test: a filter body subjected to pressure impulses from 0 to 420 bar will withstand 1.000.000 cycles
Collapse pressure filter elements		<p>N Series: 20 bar</p> <p>T Series: 80 bar</p> <p>H Series: 210 bar</p>
Bypass valve Calibration pressure	Bypass valve, differential opening pressure:	B: 6 bar ± 10%
Compatibility with fluids	<p>Filter head and bowls compatible for use with:</p> <ul style="list-style-type: none"> • mineral oils (types HH-HL-HM-HR-HV-HG as per ISO 6743/4) • water-based emulsions (types HFAE-HFAS as per ISO 6743/4) • synthetic fluids (types HS-HFDR-HFDS-HFDU as per ISO 6743/4) • water-glycol (types HFC as per ISO 6743/4) <p>Seals A Series Nitrile (Buna-N) compatible with mineral oils (types HHHL-HMHR-HV-HG as per ISO 6743/4) water-based emulsions (types HFAE-HFAS as per ISO 6743/a)</p>	<p>Filter elements As per ISO 2943; suitable for mineral oils (types HH-HL-HM-HR-HV-HG as per ISO 6743/4) and synthetic fluids (A and M series only) (types HS-HFDR-HFDS-HFDU as per ISO 6743/4) For water-based emulsions (types HFAE-HFAS as per ISO 6743/4) and fluids other than those mentioned, please consult our Sales Network Organization.</p> <p>water - glycol (types HFC as per ISO 6743/4) V Series Viton compatible with synthetic fluids (types HS-HFDR-HFDS-HFDU as per ISO 6743/4)</p>
Types of indicators	(Complete with Viton seals)	
	Description: FHP series filters are fitted with indicators switching at a pressure of 5 bar ± 10% (for N elements series) 7 bar ± 10% (for H and T elements series) 10 bar ± 10% (for H and T elements series)	
Visual indicator	With bypass 5 bar setting: V7 Series	Without bypass 7 bar setting: V8 Series
		Without bypass 10 bar setting: V9 Series
Electrical indicator	With bypass 5 bar setting: N7 Series	Without bypass 7 bar setting: N8 Series
		Without bypass 10 bar setting: N9 Series
Visual-electrical indicator	With bypass 5 bar setting: E7-K7* Series	Without bypass 7 bar setting: E8-K8* Series
		Without bypass 10 bar setting: E9-K9* Series
	*For K visual-electrical indicator, specify the voltage (f.i. K71 = LED 24 volt)	
		* { 1 - 24 Volt 2 - 115 Volt 3 - 230 Volt

MP Filtri - Specification

K - E - N Series

Supply voltage (50/60 Hz)	Resistive load	Inductive load
(V)	(A)	(A)
Vca 125	5	2
Vca 250	5	2
Vcc 30	5	3
Vcc 125	0,5	0,03
Vcc 250	0,25	0,03

CONNECTOR DIN 43650

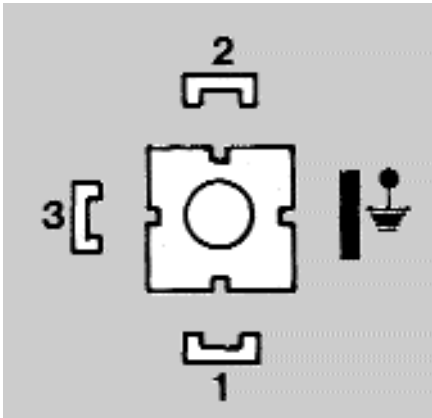

ELECTRICAL CONNECTION E - N SERIES

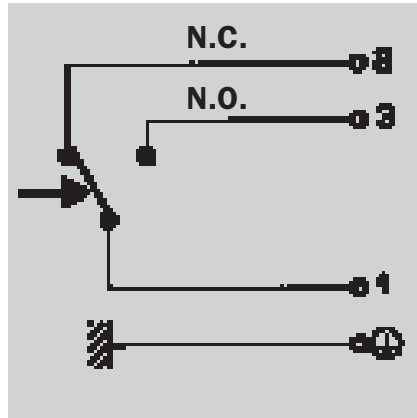

ELECTRICAL CONNECTION K SERIES

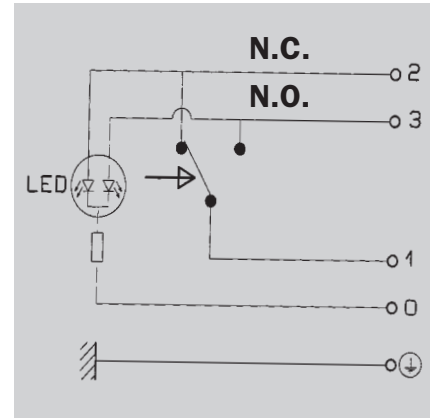

Visual V series

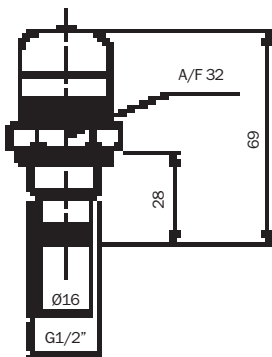

Electrical N series

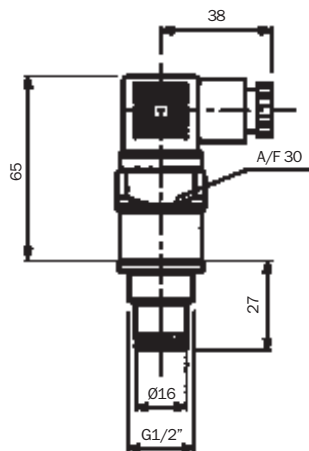

Visual - Electrical K series

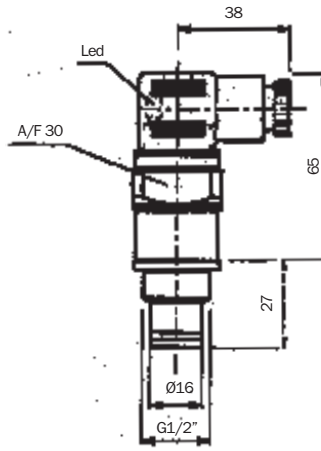

Visual - Electrical K series

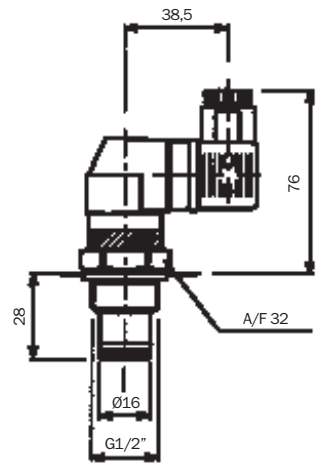

Selection & installation information

Filter elements types

A Series

Absolute inorganic microfibre filtration media, available in 3, 6, 10 and 25 micron
Example - **A03, A06, A10** or **A25**

M Series

Metal mesh media, available in 10, 25 and 60 micron
Example - **M10, M25** or **M60**

T Series

Triangular stainless steel mesh media, available in 10, 25 micron
Example - **T10, T25**

Please refer to individual pressure drop curves to obtain filter assembly pressure drop information

The following filter sizing recommendations are based using a mineral oil fluid at 30 mm²/s (cSt), with a maximum filter assembly (housing and filter element) pressure drop of 25% of the filter condition indicator (1.25 bar)

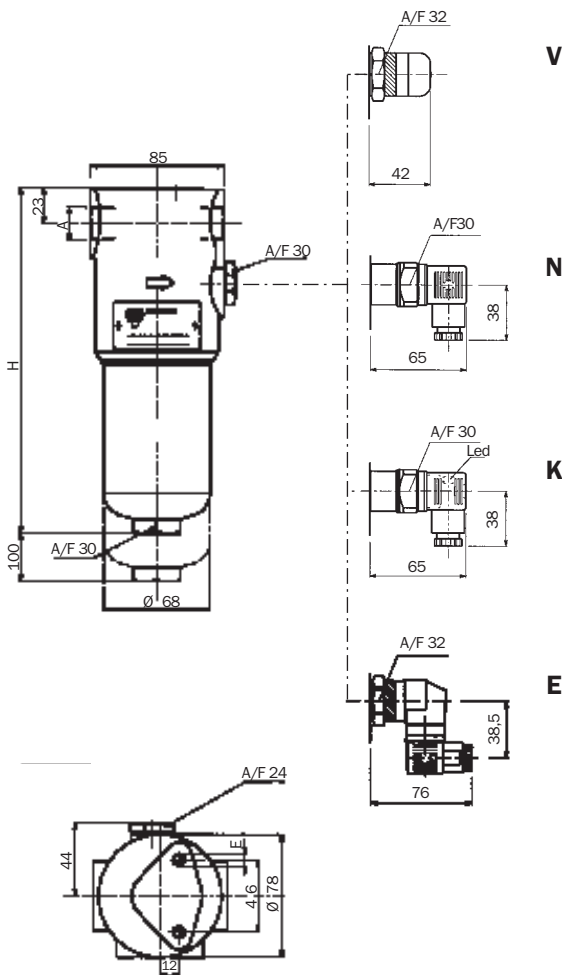

Housing pressure drop curve

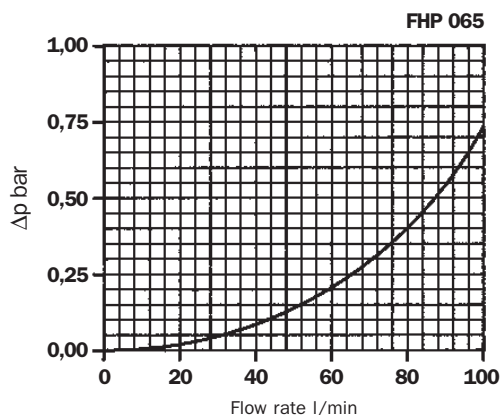

FHP 065 SERIES

FHP 065

Filter Assembly	Flow rate l/min N series *	Flow rate l/min H-T series *	Bowl Length	Port Size BSP/NPT/SAE	Weight kg **
A03	18	15	1	1/2"	3,9
A06	20	18			
A10	35	32			
A25	50	48			
T10	-	75	2	1/2"	4,2
A03	22	18			
A06	35	25		3/4"	
A10	50	45			
A25	75	65	3	3/4"	5,7
T10	-	90			
A03	35	30			
A06	60	50			
A10	75	65	-	-	-
A25	90	80			
T10	-	110			

* Flow rates with 30 mm²/s fluid viscosity
** Weight including filter element and diffuser

Lengths

Type	H
1	200
2	230
3	330

Thread connections

Type	A	E (15 mm)
G1	1/2" BSP	M8
G2	3/4" BSP	M8
G3	1/2" NPT	5/16" UNC
G4	3/4" NPT	5/16" UNC
G5	SAE 8 - 3/4" - 16 UNF	5/16" UNC
G6	SAE 12 - 1 1/16" - 12 UN	5/16" UNC

Selection & installation information

Please refer to individual pressure drop curves to obtain filter assembly pressure drop information

The following filter sizing recommendations are based using a mineral oil fluid at 30 mm²/s (cSt), with a maximum filter assembly (housing and filter element) pressure drop of 25% of the filter condition indicator (1.25 bar)

FHP 135

FHP 135 SERIES

Filter assembly	Flow rate l/min N series *	Flow rate l/min HT series *	Bowl length	Port size BSP/NPT/SAE	Weight kg **
A03	50	35	1	3/4"	7,5
A06	60	50			
A10	80	60			
A25	100	75			
T10	-	150	2	1"	9,4
A03	100	80			
A06	110	90			
A10	140	120			
A25	180	150			
T10	-	180			

* Flow rates with 30 mm²/s fluid viscosity
** Weight including filter element and diffuser

Lengths

Type	H
1	260
2	375

Thread connections

Type	A	E (15 mm)
G1	3/4" BSP	M10
G2	1" BSP	M10
G3	3/4" NPT	3/8" UNC
G4	1" NPT	3/8" UNC
G5	SAE 12 - 1 1/16" - 12 UN	3/8" UNC
G6	SAE 16 - 1 5/16" - 12 UN	3/8" UNC

Flange connections

Type	Port A	B	C	D	E (15 mm)
F1	3/4" SAE - 3000 PSI/M	47,63	22,23	M10	M10
F2	1" SAE - 3000 PSI/M	52,37	26,19	M10	M10
F3	3/4" SAE - 3000 PSI/UNC	47,63	22,23	3/8" UNC	3/8" UNC
F4	1" SAE - 3000 PSI/UNC	52,37	26,19	3/8" UNC	3/8" UNC
F5	3/4" SAE - 6000 PSI/M	50,80	23,80	M10	M10
F6	3/4" SAE - 6000 PSI/UNC	50,80	23,80	3/8" UNC	3/8" UNC

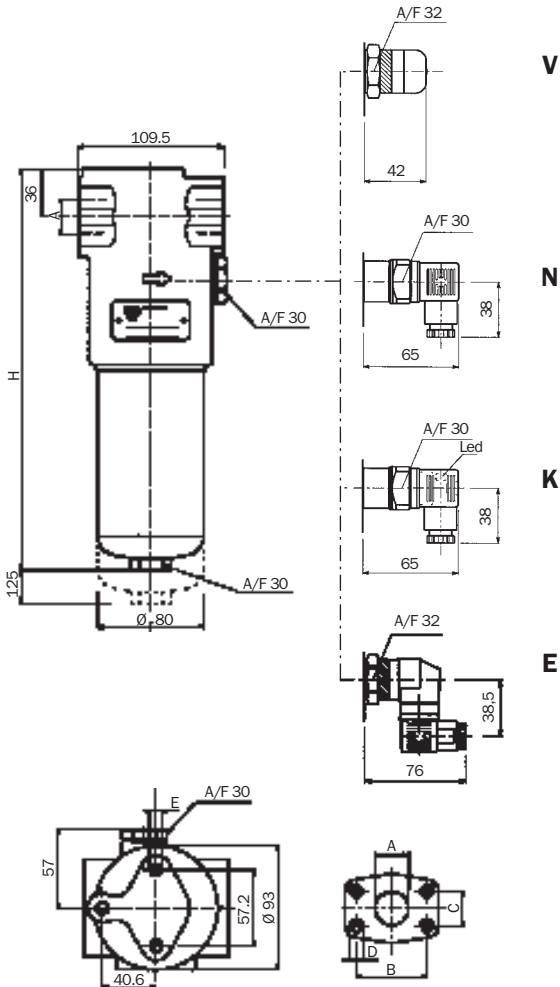

Housing pressure drop curve

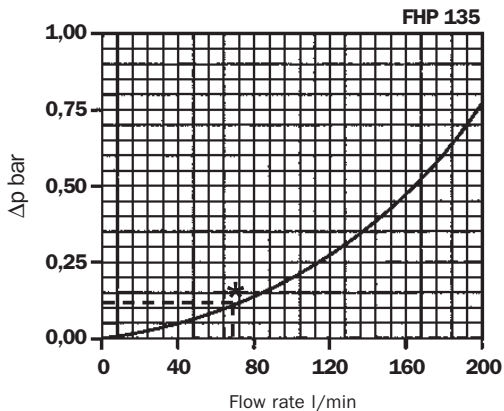

Selection & installation information

Please refer to individual pressure drop curves to obtain filter assembly pressure drop information

The following filter sizing recommendations are based using a mineral oil fluid at 30 mm²/s (cSt), with a maximum filter assembly (housing and filter element) pressure drop of 25% of the filter condition indicator (1.25 bar)

FHP 320/321 SERIES

FHP 320/321

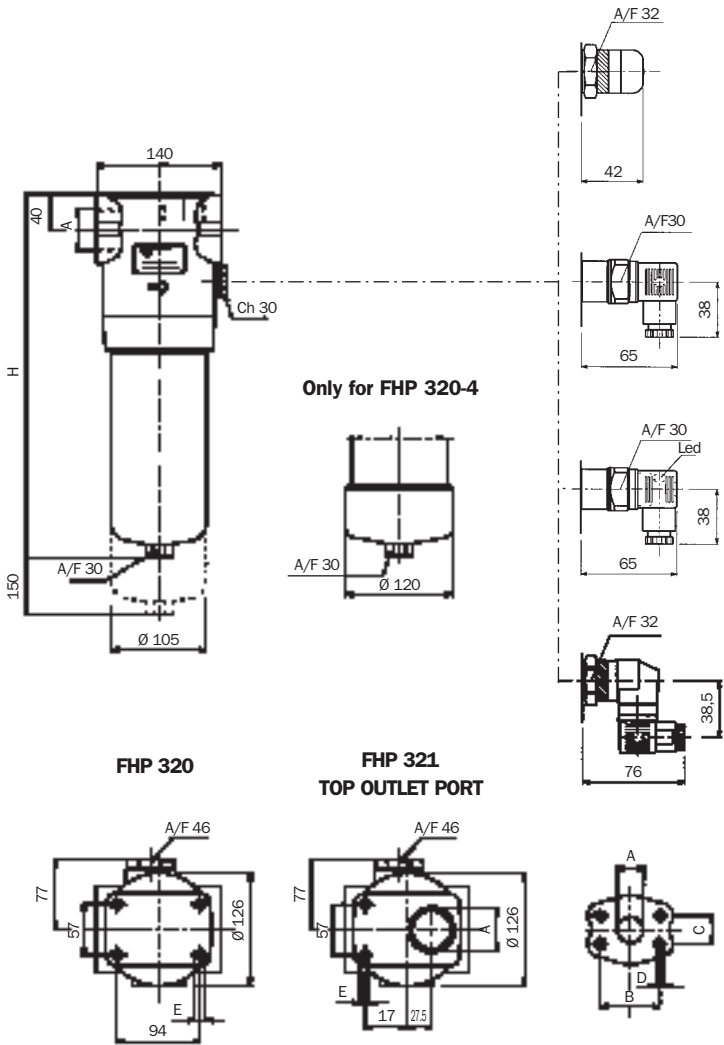

FHP 320

**FHP 321
TOP OUTLET PORT**

Filter assembly	Flow rate l/min N series *	Flow rate l/min H-T series *	Bowl length	Port size BSP/NPT/SAE	Weight kg **
V					
A03	100	65	1	1 1/4"	14,5
A06	120	80			
A10	140	100			
A25	180	150			
T10	–	200			
N					
A03	210	150	2	1 1/4"	16,5
A06	250	180			
A10	300	220			
A25	350	250			
T10	–	275			
K					
A03	250	225	3	1 1/2"	22,5
A06	280	250			
A10	320	280			
A25	350	340			
T10	–	360			
E					
A03	300	250	4	1 1/2"	25,5
A06	340	275			
A10	375	320			
A25	450	380			
T10	–	450			

* Flow rates with 30 mm²/s fluid viscosity
** Weight including filter element

Lengths

Type	H
1	300
2	420
3	561
4	691

Thread connections

Type	A	E (15 mm)
G1	1 1/4" BSP	M12
G2	1 1/2" BSP	M12
G3	1 1/4" NPT	1/2" UNC
G4	1 1/2" NPT	1/2" UNC
G5	SAE 20 - 1 5/8" - 12 UN	1/2" UNC
G6	SAE 24 - 1 7/8" - 12 UN	1/2" UNC

Flange connections

Type	Port A	B	C	D	E (15 mm)
F1	1 1/4" SAE - 3000 PSI/M	58,72	30,18	M10	M12
F2	1 1/2" SAE - 3000 PSI/M	69,85	35,71	M12	M12
F3	1 1/4" SAE - 3000 PSI/UNC	58,72	30,18	7/16" UNC	1/2" UNC
F4	1 1/2" SAE - 3000 PSI/UNC	69,85	35,71	1/2" UNC	1/2" UNC
F5	1 1/4" SAE - 6000 PSI/M	66,68	31,75	M14	M12
F6	1 1/4" SAE - 6000 PSI/UNC	66,68	31,75	1/2" UNC	1/2" UNC

Housing pressure drop curve

FHP 320/321

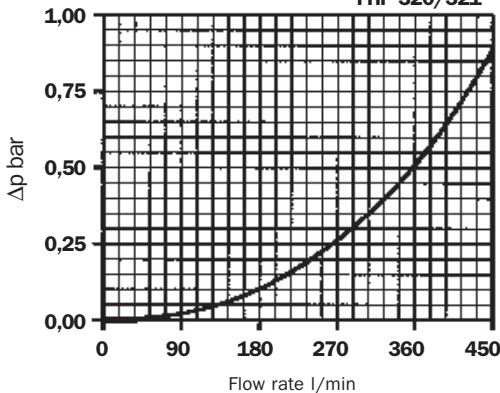

Selection & installation information

Please refer to individual pressure drop curves to obtain filter assembly pressure drop information

The following filter sizing recommendations are based using a mineral oil fluid at 30 mm²/s (cSt), with a maximum filter assembly (housing and filter element) pressure drop of 25% of the filter condition indicator (1.25 bar)

FHP 325

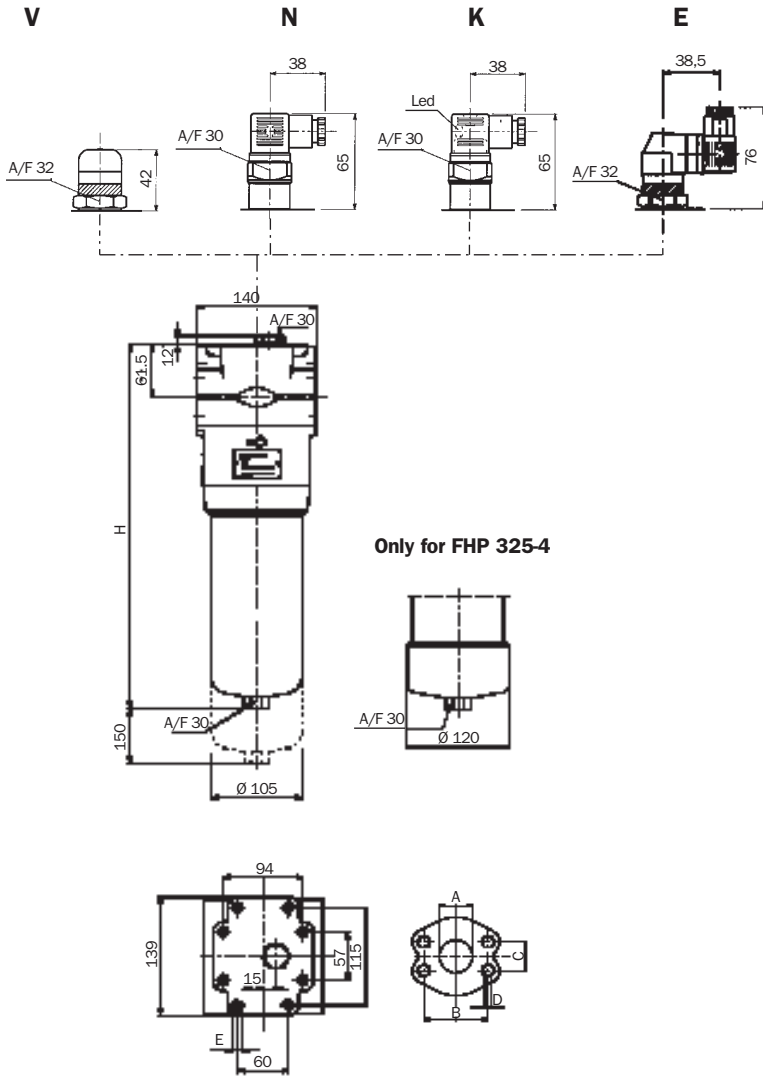

FHP 325 SERIES

Filter assembly	Flow rate l/min N series *	Flow rate l/min H-T series *	Bowl length	Port size BSP/NPT/SAE	Weight kg **
A03	100	65	1	2"	20,5
A06	120	80			
A10	140	100			
A25	180	150			
T10	–	200	2	2"	22,5
A03	210	150			
A06	250	180			
A10	300	220			
A25	350	250	3	2"	28,5
T10	–	275			
A03	250	225			
A06	280	250			
A10	320	280	4	2"	31,5
A25	350	340			
T10	–	360			
A03	300	250			
A06	340	275	4	2"	31,5
A10	375	320			
A25	450	380			
T10	–	450			

* Flow rates with 30 mm²/s fluid viscosity
** Weight including filter element

Lengths

Type	H
1	328
2	448
3	589
4	719

Housing pressure drop curve

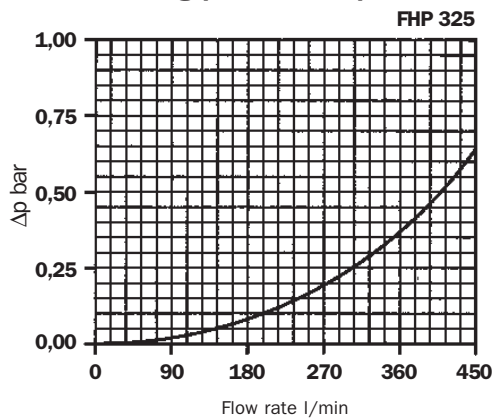

Flange connections

Type	Port A	B	C	D	E (15 mm)
F1	2" SAE - 3000 PSI/M	77,77	42,88	M12	M12
F2	2" SAE - 3000 PSI/UNC	77,77	42,88	1/2" UNC	1/2" UNC
F5	2" SAE - 6000 PSI/M	96,82	44,45	M20	M12
F6	2" SAE - 6000 PSI/UNC	96,82	44,45	3/4" UNC	3/4" UNC

General

Pressure drop versus flow rate curve information for both housing and filter elements is in accordance with ISO 3968

Filter assembly pressure drop - $\Delta p_{\text{Total}} = \Delta p_{\text{Housing}} + \Delta p_{\text{Filter element}}$

Housing pressure drop - The housing pressure drop is proportional to the fluid density

Filter element pressure drop - Filter element pressure drop is proportional to kinematic viscosity therefore always check the fluid operating temperature and fluid type to obtain the working viscosity according to the following formula:

$\Delta p_1 \text{ Filter element} = (\text{working viscosity} / \text{brochure viscosity}) \times \Delta p \text{ filter element}$

Brochure viscosity 30 mm²/s (cSt)

Filter assembly sizing example

- Customer requires a 70 l/min filter assembly
- Mineral oil fluid: ISO VG 46 (46 mm²/s (cSt) at 40°C)
- A10 - 10 micron absolute filtration

Selection :

- **Housing pressure drop** - FHP 135-2 with 70 l/min $\Delta p = 0.12$ bar (see curve on page 7)
- **Filter element pressure drop** (brochure viscosity) - HP 135-2A10AH with 70 l/min $\Delta p = 0.64$ bar (see curve on page 12)
- **Filter element pressure drop** (working viscosity) - With 46 mm²/s (cSt) $\Delta p_1 = 0.64 \times (46/30) = 0.98$ bar
- **Filter assembly pressure drop** $\Delta p_{\text{Total}} = \Delta p_{\text{Housing}} + \Delta p_1 \text{ Filter element} = 0.12 + 0.98 = \mathbf{1.10 \text{ bar}^*}$ } *Acceptable pressure drop value as per our recommendations

Bypass valves pressure drop

The curves were obtained using a mineral oil with a density of 0,86 kg/dm³.
The Δp varies proportionally to the density.

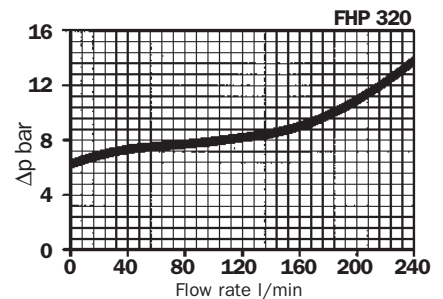
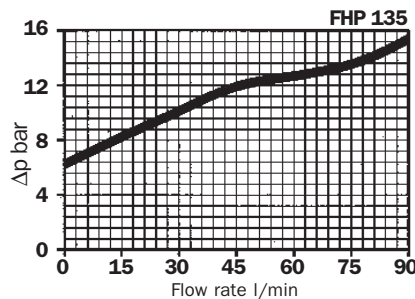
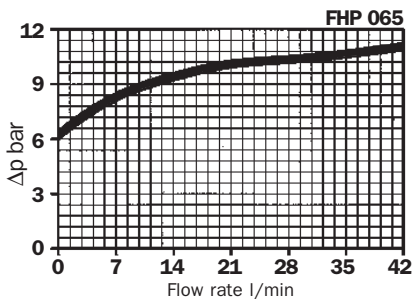

Reverse flow valves pressure drop

The curves were obtained using a mineral oil with a density of 0,86 kg/dm³.
The Δp varies proportionally to the density.

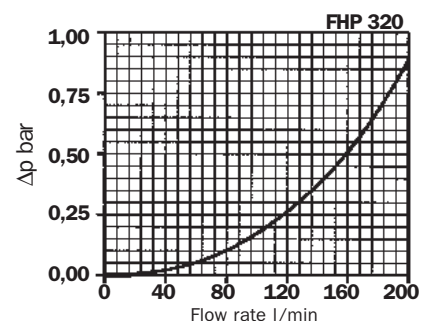
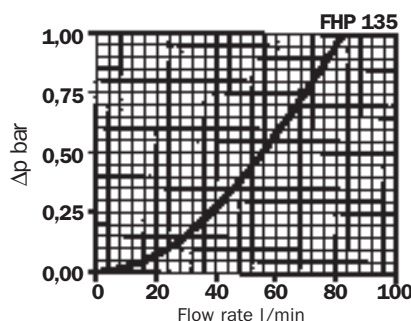

Filter elements - N - ΔP 20bar

The curves were obtained using a mineral oil with a kinematic viscosity of 30 mm²/s (cSt).
The Δp varies proportionally to the fluid kinematic viscosity.

For the metal mesh filter elements curves (M series), please consult our Sales and Network Organization

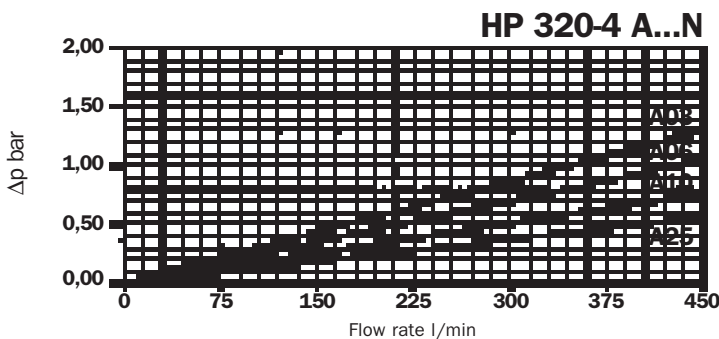
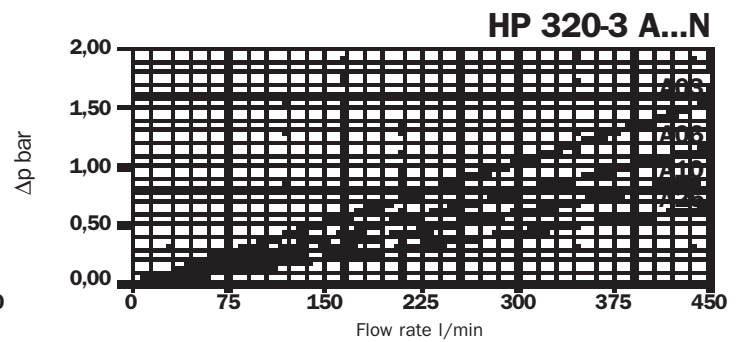
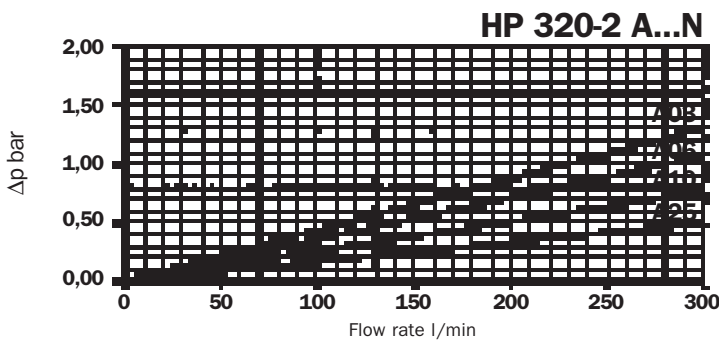
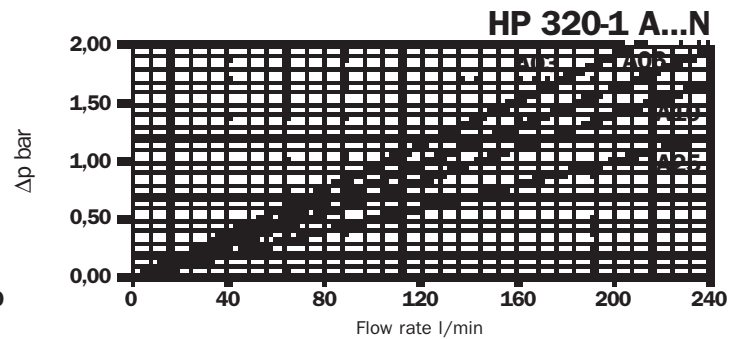
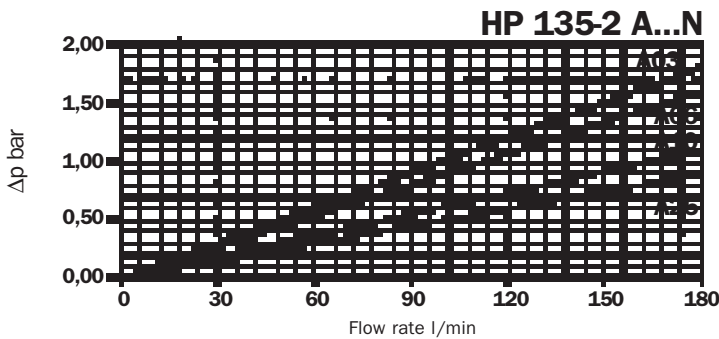
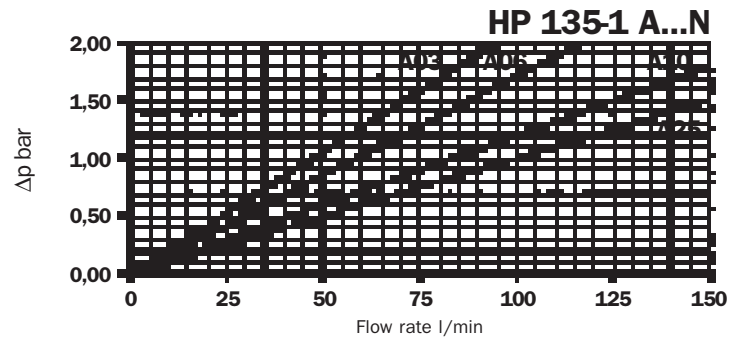
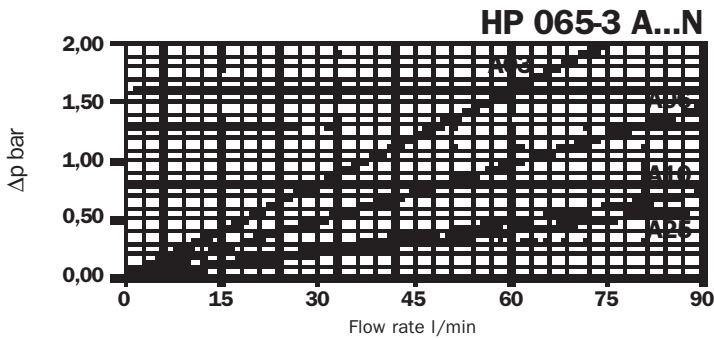
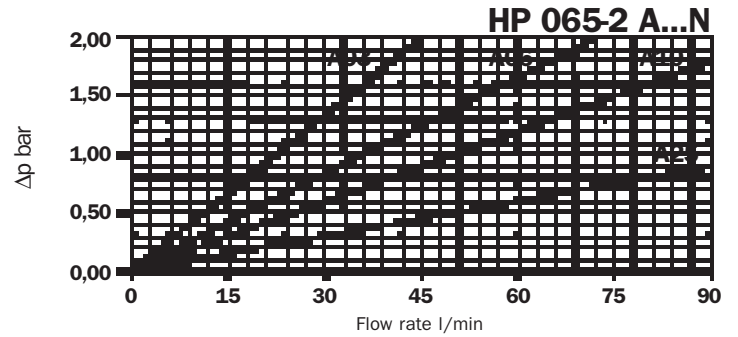
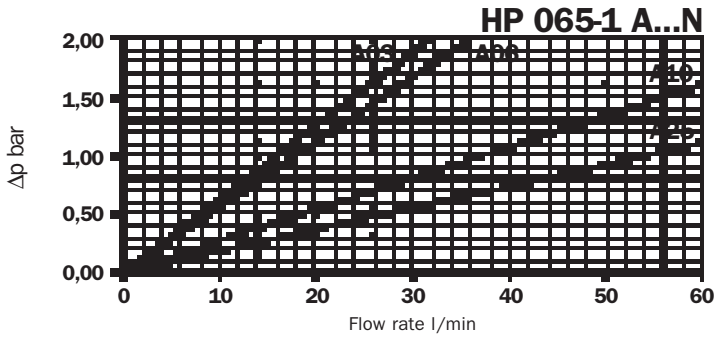

Filter elements - H - ΔP 210bar

The curves were obtained using a mineral oil with a kinematic viscosity of 30 mm²/s (cSt).
The Δp varies proportionally to the fluid kinematic viscosity.

For the stainless steel mesh filter elements curves (T series), please consult our Sales and Network Organization

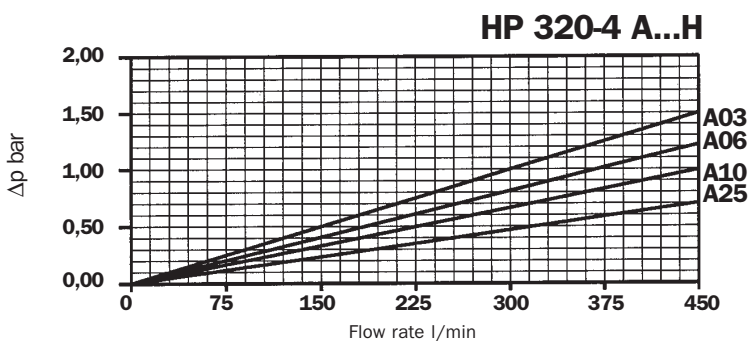
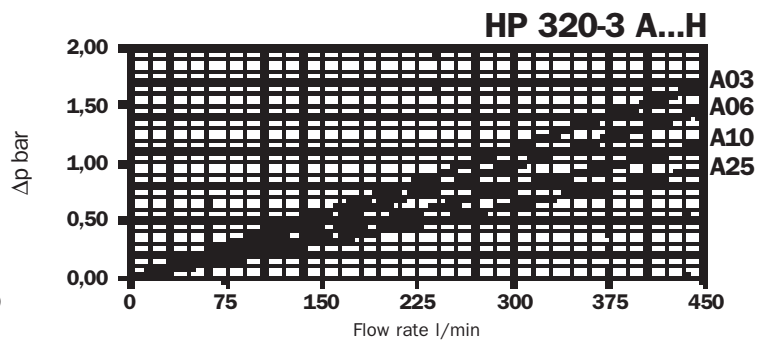
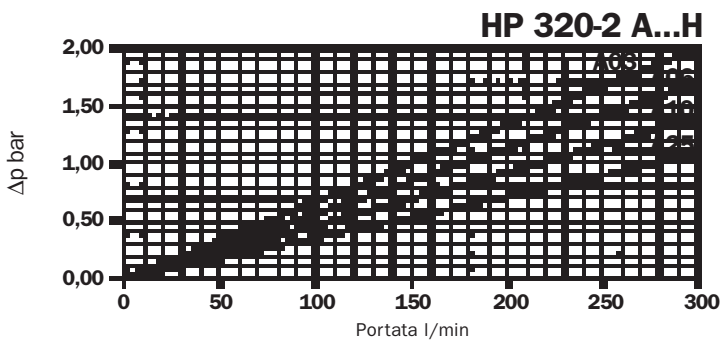
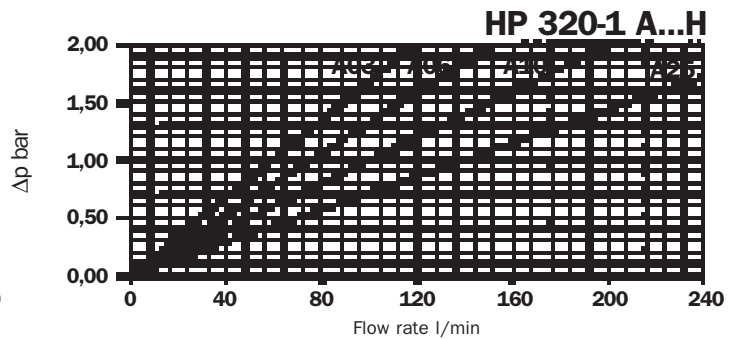
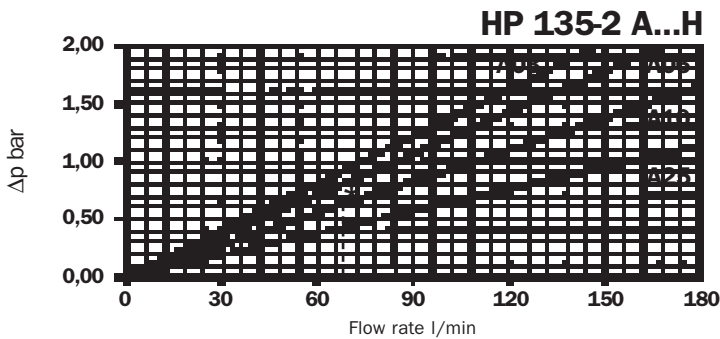
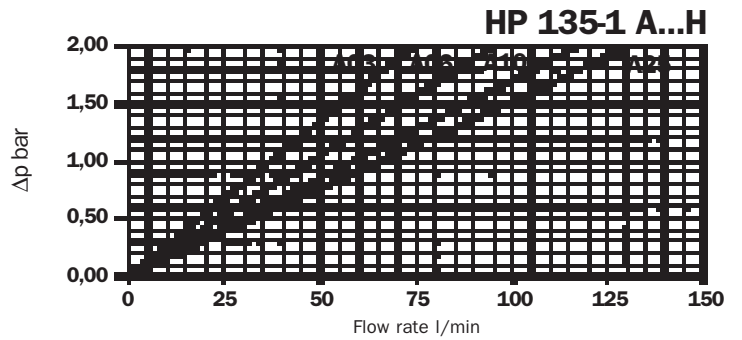
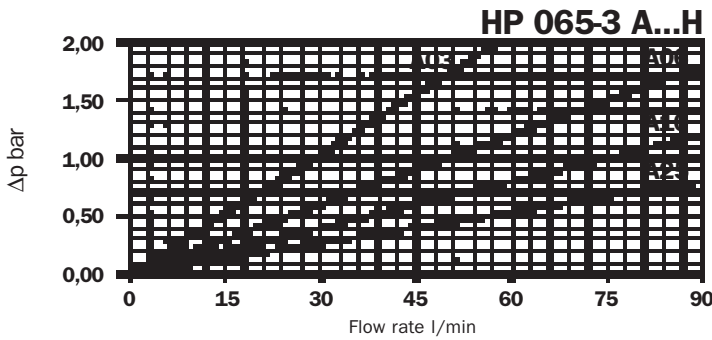
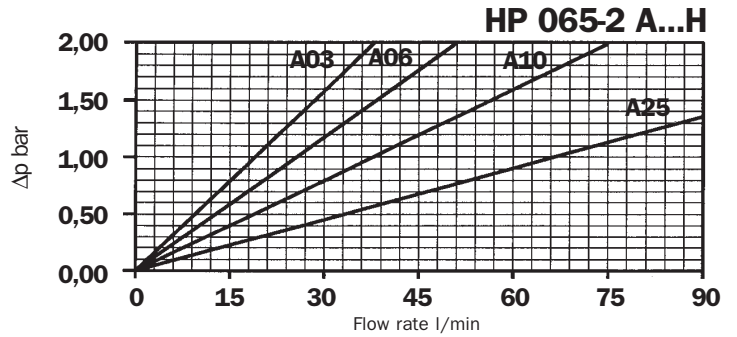
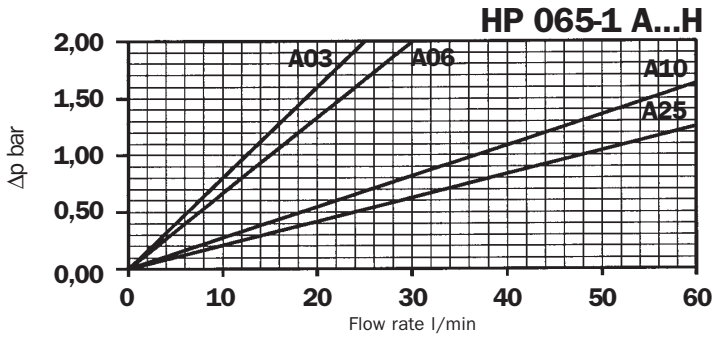

Ordering information

FHP

Nominal sizes

065
135
320
321 - Top Outlet Port
325

Bowl lengths

FHP 065 = 1, 2, 3
FHP 135 = 1, 2
FHP 320 = 1, 2, 3, 4
FHP 321 = 1, 2, 3, 4 Filter elements HP 320 series
FHP 325 = 1, 2, 3, 4 Filter elements HP 320 series

Integral bypass valve

S	Without bypass
B	With bypass
W	With reverse flow
R	With reverse flow + bypass (Not available for FHP 065)

Seals

A	Nitrile (Buna-N)
V	Viton

Filter condition indicator

S	With threaded hole only
T2	With plug
V7	Visual 5 bar
V8	Visual 7 bar
V9	Visual 10 bar
N7	Electrical 5 bar
N8	Electrical 7 bar
N9	Electrical 10 bar
E7	Visual - electrical 5 bar
E8	Visual - electrical 7 bar
E9	Visual - electrical 10 bar
K7*	Visual - electrical 5 bar
K8*	Visual - electrical 7 bar
K9*	Visual - electrical 10 bar

} 1 - 24 Volt
 } 2 - 115 Volt
 } 3 - 230 Volt

*For K visual-electrical indicator, specify the voltage (i.e. K71 = LED 24 volt)

Collapse pressure series

N	20 bar
T	80 bar
H	210 bar

Filter elements

A03	Inorganic microfibre Bx ≥200
A06	
A10	
A25	Square wire mesh
M10	
M25	Stainless steel wire mesh
M60	
T10	
T25	

Ports option

Type	065	135	320	321	325
G1	1/2" BSP	3/4" BSP	1 1/4" BSP	1 1/4" BSP	-
G2	3/4" BSP	1" BSP	1 1/2" BSP	1 1/2" BSP	-
G3	1/2" NPT	3/4" NPT	1 1/4" NPT	1 1/4" NPT	-
G4	3/4" NPT	1" NPT	1 1/2" NPT	1 1/2" NPT	-
G5	SAE 8	SAE 12	SAE 20	SAE 20	-
G6	SAE 12	SAE 16	SAE 24	SAE 24	-
F1	-	3/4" SAE 3000 PSI/M	1 1/4" SAE 3000 PSI/M	-	2" SAE 3000 PSI/M
F2	-	1" SAE 3000 PSI/M	1 1/2" SAE 3000 PSI/M	-	2" SAE 3000 PSI/UNC
F3	-	3/4" SAE 3000 PSI/UNC	1 1/4" SAE 3000 PSI/UNC	-	-
F4	-	1" SAE 3000 PSI/UNC	1 1/2" SAE 3000 PSI/UNC	-	-
F5	-	3/4" SAE 6000 PSI/M	1 1/4" SAE 6000 PSI/M	-	2" SAE 6000 PSI/M
F6	-	3/4" SAE 6000 PSI/UNC	1 1/4" SAE 6000 PSI/UNC	-	2" SAE 6000 PSI/UNC

HP

Replacement element

MP Filtri - Filtration products will only be guaranteed if original MP Filtri replacement elements and spares are used

Data hold in this publication are given only for indicative purposes. MP Filtri reserves to introduce modifications to described items in every moment either for technical or commercial reasons. Copyright reserved.

CONTAMINATION CODES ISO 4406		CORRESPONDENT CODES NAS 1638	RECOMMENDED FILTRATION DEGREE	TYPICAL APPLICATIONS
5 µm	15 µm		$\beta_x \geq 200$	
12	9	3	3	High precision and laboratory servo-systems
15	11	6	3-6	Robotic and servo-systems
16	13	7	10-12	Very sensitive systems where a high degree of reliability is required
18	14	9	12-15	General equipment of limited reliability
19	16	10	15-25	General equipment of limited reliability
21	18	12	25-40	Low - pressure equipment not in continuous service

Reverse flow valve - Drawing

FHP 135 - FHP 320 - 321 - 325 SERIES

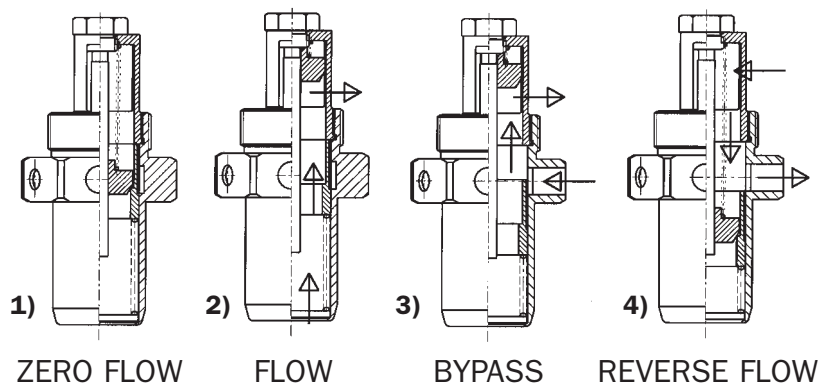
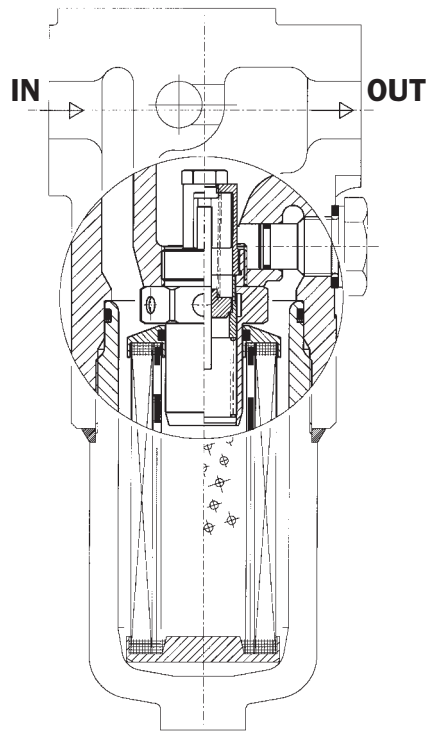



Head Quarter :

MP FILTRI S.p.A. Italy

Via Matteotti, 2
20060 Pessano con Bornago (Milano) Italy
Tel. ++39.02/95703.1
Fax ++39.02/95741497-95740188
email: sales@mpfiltri.com
<http://www.mpfiltri.com>



GREAT BRITAIN

MP FILTRI U.K. Ltd.

Bourton Industrial Park
Bourton on the Water
Gloucestershire GL54 2HQ UK
Phone: 01451-822522
Fax: 01451-822282
email: sales@mpfiltri.co.uk
<http://www.mpfiltri.co.uk>

GERMANY

MP FILTRI D GmbH

Am Wasserturm 5
D-66265 Heusweiler/Holz
Phone: 06806/85022-0
Fax: 06806/85022-18
email: mpfiltrink@aol.com

FRANCE

MP FILTRI FRANCE

B.P. 325
01603 Trevoux Cedex
Tel: 04.74.08.84.78
Telefax: 04.74.08.80.45
email: mpfiltrifrance@wanadoo.fr

USA

MP FILTRI USA Inc.

2055 Quaker Pointe Drive
Quakertown, PA 18951
Phone: 215-529-1300
Fax: 215-529-1902
email: mpusasales@aol.com
<http://www.mpfiltriusa.com>

CANADA

MP FILTRI CANADA Inc.

210 Jacob Keffer Parkway Concord,
Ontario Canada L4K 4W3
Phone: 905-303-1369
Fax: 905-303-7256
email: mail@mpfiltricanada.com
<http://www.mpfiltricanada.com>